

Altis Gen5

THORN

96671937 ALG5 GB 2052W 0.85A 565V 3CH RDMX

IP66 IK08    Ta45

Altis Gen5

Class I, DMX RDM programmable gearbox, with 3 independent output channels and IP66 enclosure, for TV broadcasting applications. Suitable for dedicated 432 / 456 / 480 / 504 LED Altis floodlight, to be installed remotely up to 200m from the floodlight. Nominal input voltage: 200-440, output current 850mA with DMX RDM configurable single-channel, IEEE 1789 flicker recommended practice compliant suitable for super slow motion camera filming, surge level 10kV for both common mode and differential.

Connection from mains via terminal blocks. Mains supply must be fused according to local safety regulations.

Weight: 6.2 kg.



TLG_ALT5_F_GB_1700.jpg

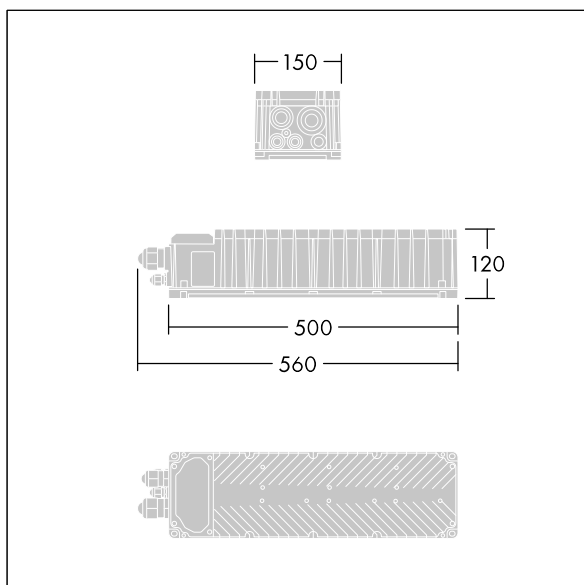

TLG_ALT5_M_GB.wmf

I valori contrassegnati con l'asterisco (*) sono valori di misurazione. I valori si riferiscono a una temperatura ambiente di 25°C salvo diversa specifica.

I prodotti Thorn Lighting sono soggetti a continui sviluppi. Ci riserviamo la facoltà di apportare modifiche tecniche o formali ai nostri prodotti senza ulteriori pubblicazioni.

© Thorn Lighting